

CADİLLAC CAMLI DOLAP GÖVDE

CADİLLAC GLASS CABINET BODY

PARTS THAT CAN BE SERVICED AFTER SALES

SSH OLABİLECEK PARÇALAR

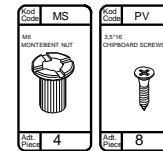
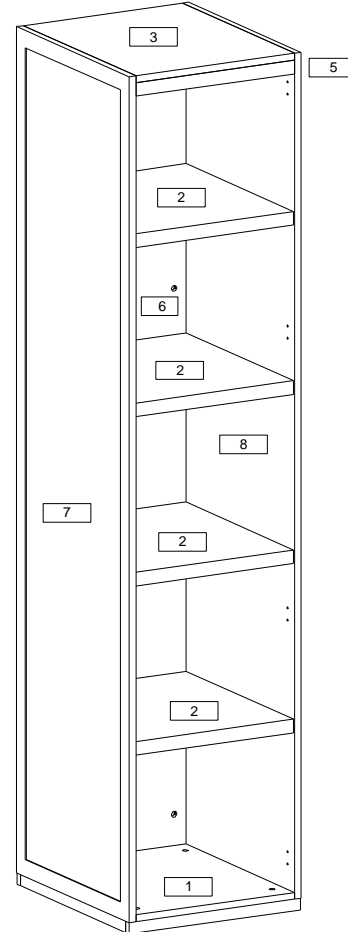

Code	Code	Code	Code	Code	Code	Code	Code	Code	Code	Code	Code	Code	Code	Code	Code
Items	A	B	C	D	TA	TA5	H2	H6	E	MV	AV	KV	MS	PV	
Quantities	16	16	16	8	2	2	2	2	16	4	10	16	4	8	

SİPARİŞ KODU	PARÇA KODU	PARÇA ADI	ADET
151011806060201	1	ALT TABLA / BOTTOM TABLE	1
150.16.00.10.08	2	CAMLI BLOK LEDLİ RAF / GLASSED BLOCK LED SHELF	4
151011806060202	3	ÜST TABLA / TOP TABLE	1
151011806060203	4	MALZEME PAKETİ / MATERIAL PACKAGE	1
150.16.00.10.09	5	METAL LED PROFİL / METAL LED PROFILE	1
151011806060102	6	ARKA PANO / BACK PANEL	1
150.07.00.00.47	7	CAMLI YAN TABLA / GLAZED SIDE TABLE	1
151011806060101	8	YAN TABLA / SIDE TABLE	1

In case you need a sparepart, please indicate "Model Code" and "Accessory Code" shown in the assembly instructions.
LET'S PAY ATTENTION TO THE CODE AND LOCATION OF THE MATERIALS WHEN POSITIONING

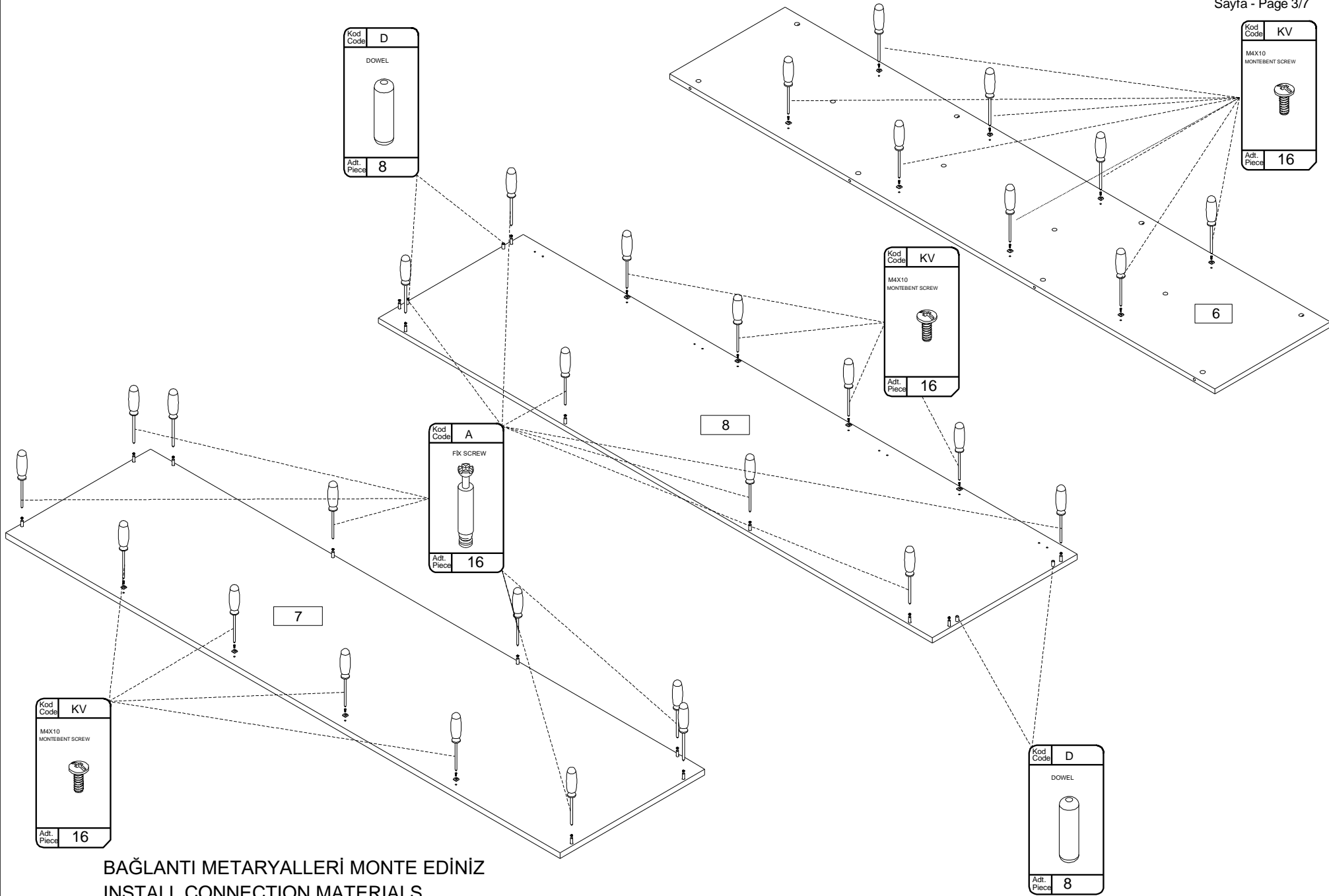

BAĞLANTI METARYALLERİ MONTE EDİNİZ
 INSTALL CONNECTION MATERIALS

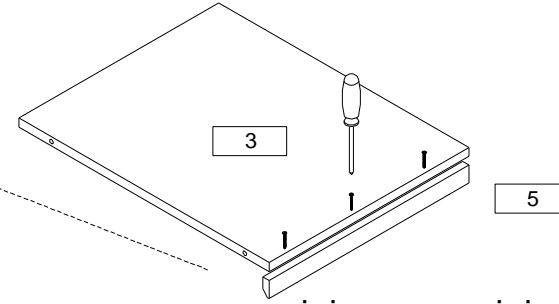
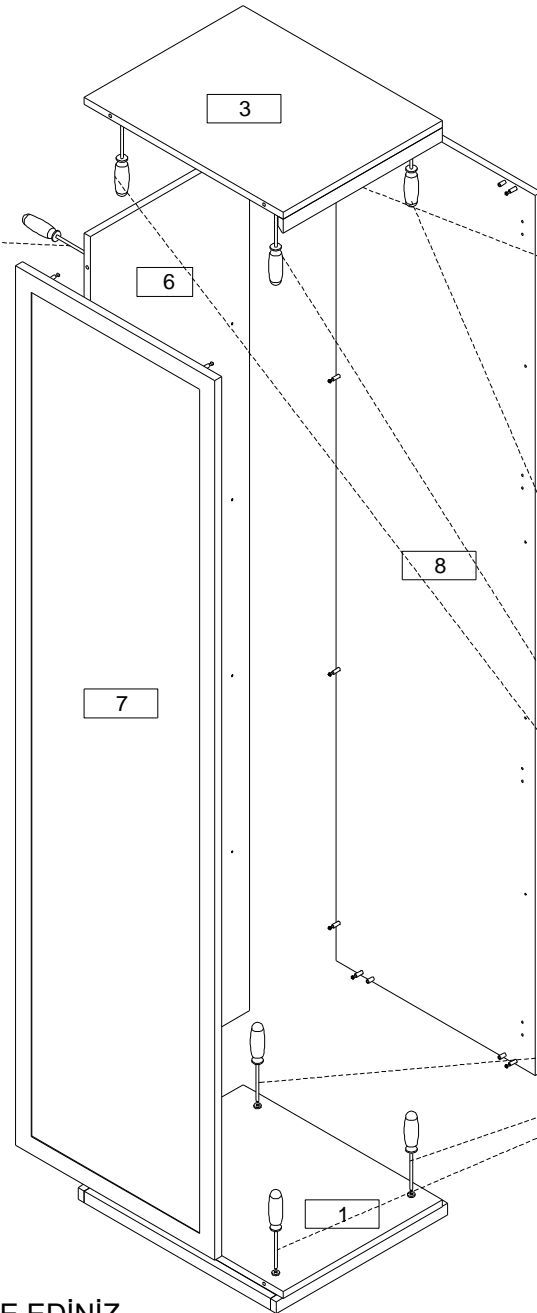
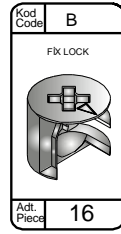

LED METALİNİ MONTE EDİNİZ
INSTALL THE LED METAL

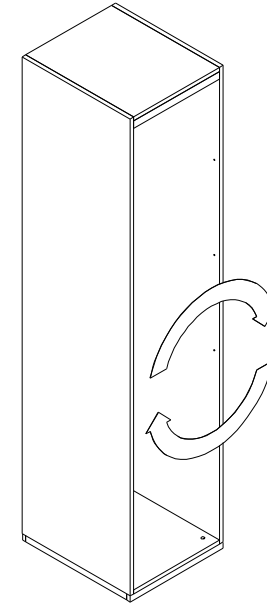
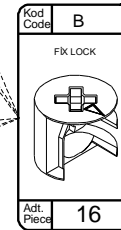

YAN TABLALARIN YERİNİ DEĞİŞTİREREK
SAĞ VEYA SAĞ MODÜL YAPABİLİRSİNİZ

YOU CAN MAKE A RIGHT OR RIGHT
MODULE BY CHANGING THE LOCATIONS
OF THE SIDE TABLES

BAĞLANTI METARYALLERİ MONTE EDİNİZ
INSTALL CONNECTION MATERIALS

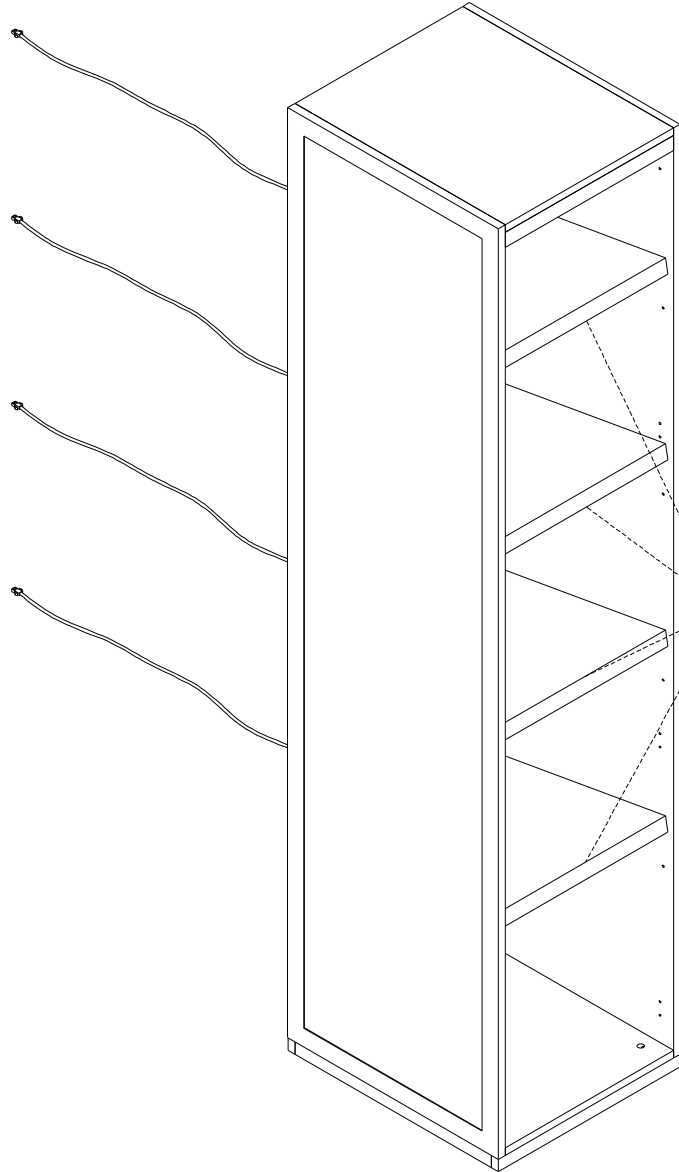

AÇILI ŞEKİLDE TAKINIZ
INSTALL IT AT AN ANGLE

BAĞLANTI METARYALLERİ MONTE EDİNİZ
INSTALL CONNECTION MATERIALS

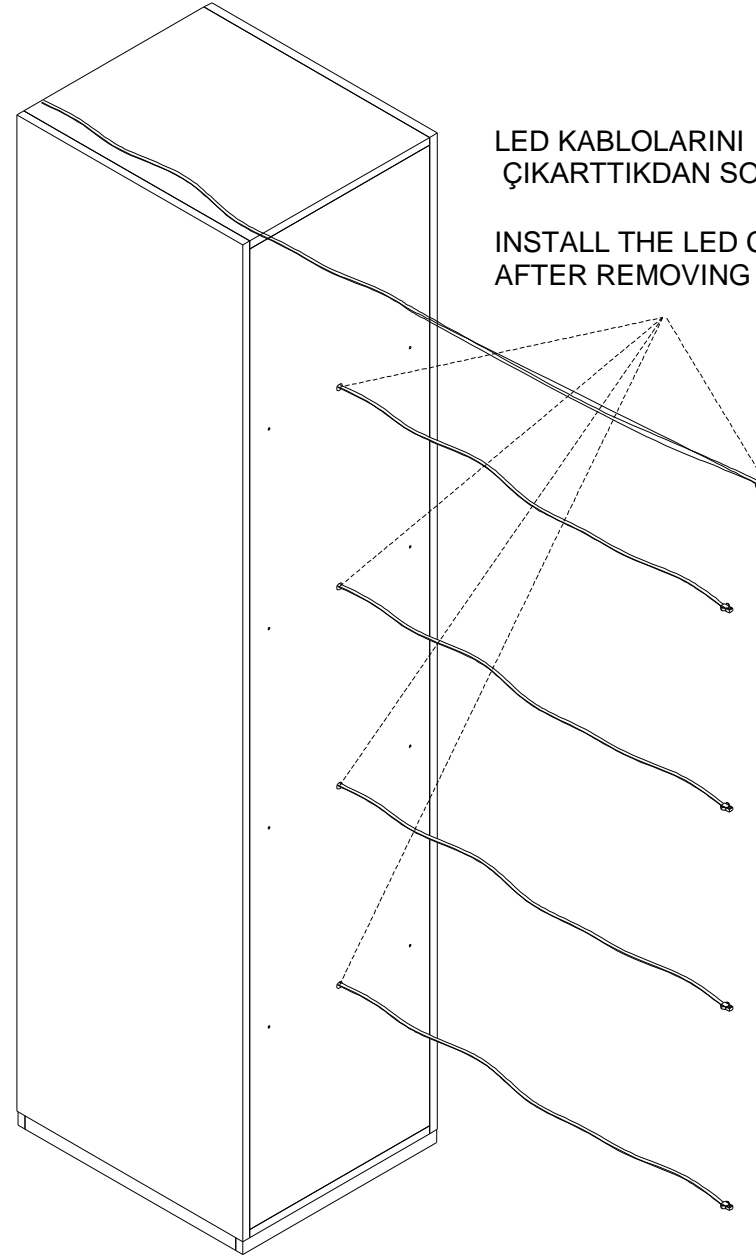

LED KABLolarINI
ÇIKARTTIKDAN SONRA TAKINIZ

INSTALL THE LED CABLES
AFTER REMOVING THEM

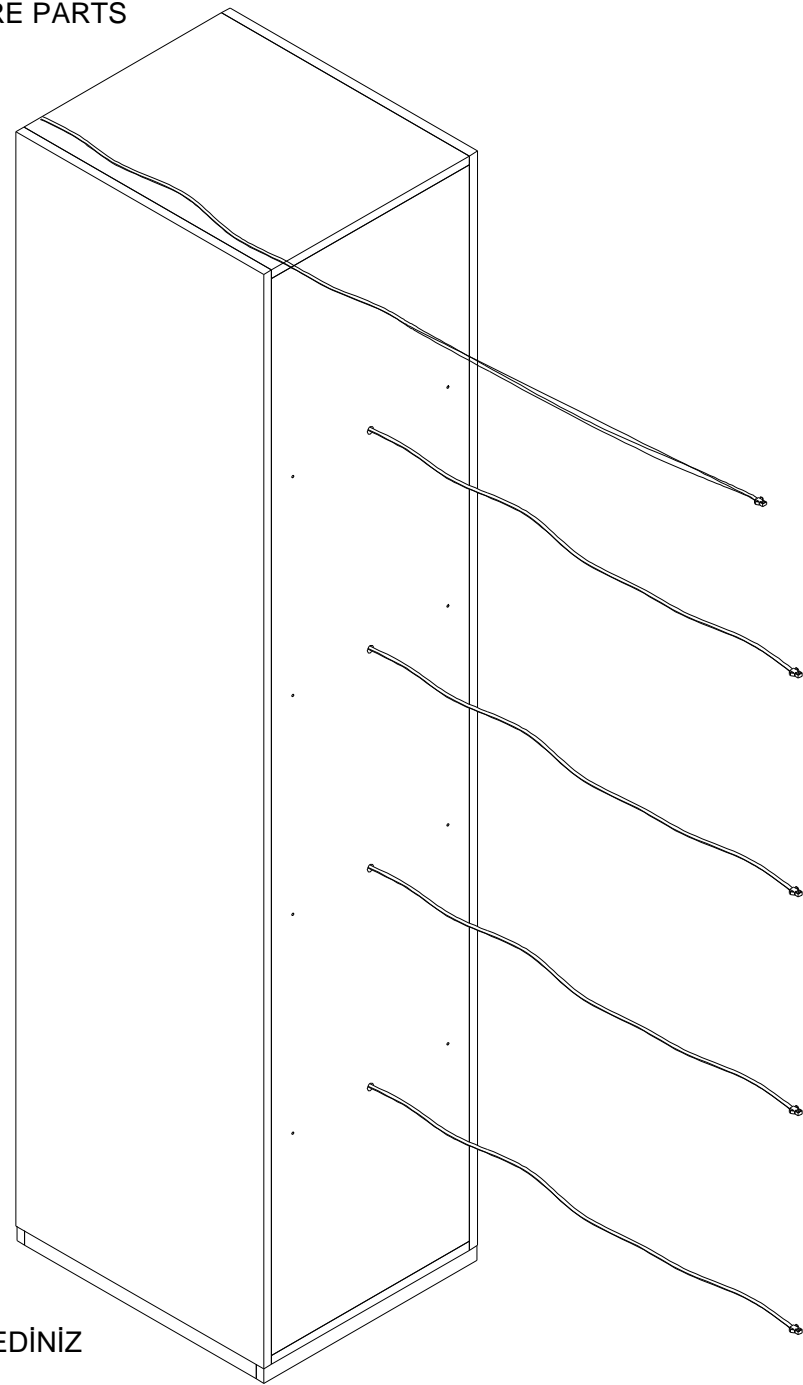

LED KABLORINI
TOPLAYICIYA TAKINIZ

INSTALL LED CABLES
TO THE COLLECTOR

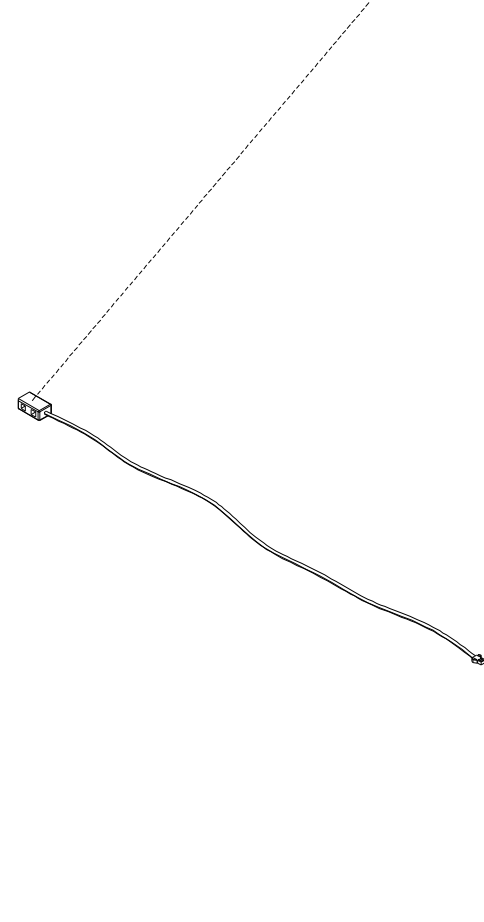

BAĞLANTI METARYALLERİ MONTE EDİNİZ
INSTALL CONNECTION MATERIALS

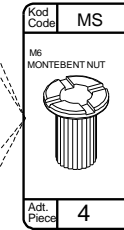
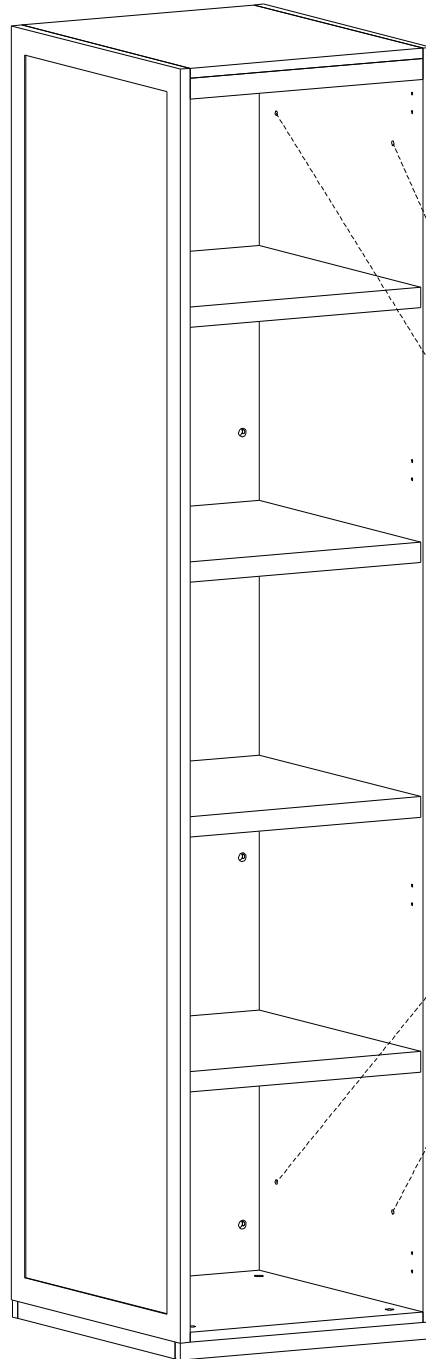

DİĞER MODÜLLERİ BİRLEŞTİRMEK
İÇİN İÇTEN MONTAJ

INSTALL FROM THE INTERIOR TO
COMBINE OTHER MODULES

BAĞLANTI METARYALLERİ MONTE EDİNİZ
INSTALL CONNECTION MATERIALS