

ASTON 3 LÜ KANEPE

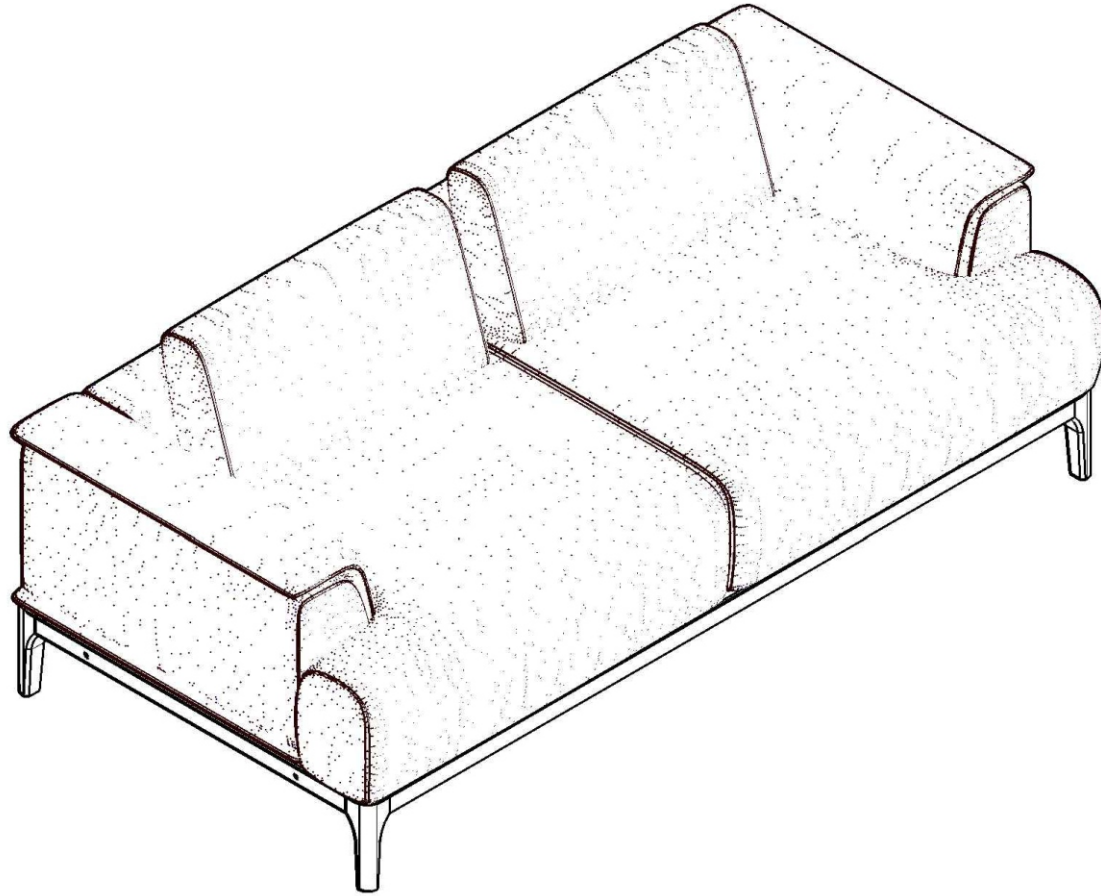

Assembly Instruction

Page 3/1

Sayın Müşteri,

Satın almış olduğunuz bu ürün size ulaşmadan önce tüm test edilmiş, kontrol edilmiş ve paketlenmiştir. Ancak nakliye sırasında bazı parçalar zarar görebilir. Böyle bir durumla karşılaşırsanız ürünün tamamını geri göndermeyin ve sadece hasarlı parçayı ve malzemeyi isteyin.

Gerekli parça ve malzemelerin kodunu kurulumda bulabilirsiniz.
Manuel.

Montaja başlamadan önce kollarıdan çıkan ürünler eksiksizdir ve zararsız, olduğundan emin olun.

Birden fazla ürün satın aldıysanız montajı tamamlamadan tek bir ürünü, bitirmeden ikinci ürünü açarak karışıklık yaratmayınız. Kurulumu başlamadan önce her parçayı hafif nemli bir bezle silin ve kurulumu başlatın,
Başlayabilirsiniz.

Lütfen mobilyalarınızı amacı dışında kullanmayınız.

Dear Customer,

Before this product you have purchased reaches you, all of our has been tested and checked and packaged.

However, some parts may be damaged during transportation.

If you encounter such a situation, do not send the entire product back and simply ask for the damaged part and the material.

You can find the code of the required parts and materials in the installation manual.

Before starting the assembly, the products coming out of the boxes are complete and harmless make sure it is.

If you have purchased more than one product, without completing the assembly of a single product,

Do not cause confusion by opening the second product.

Before starting the installation, wipe each part with a slightly damp cloth and start the installation.

You can start.

Please do not use your furniture for other than its intended purpose.

PAKET İÇERİ / PACKAGE INCLUDED

PAKET NO PACKAGE NO	PARÇA NO / PART NO
1 PK	1 AYK KASA AKSESUAR

In case you need a sparepart, please indicate "Model Code" and "Accessory Code" shown in the assembly instructions.





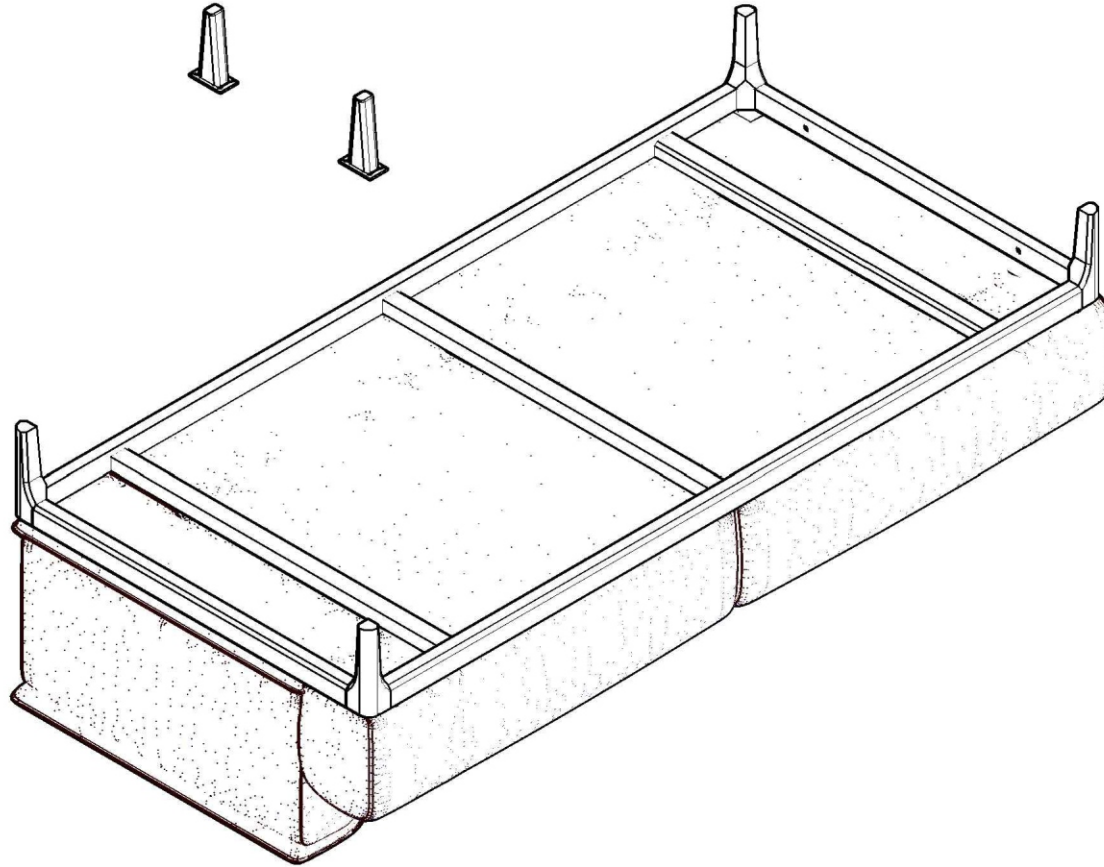

LET'S PAY ATTENTION TO THE CODE AND LOCATION OF THE MATERIALS WHEN POSITIONING

ASTON 3 LÜ KANEPE

INSTALLATION DIAGRAM WITH SPARE PARTS

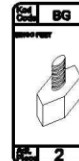

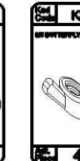
PARÇA KODU PART CODE	PARÇA ADI / TRACK NAME	ADET PIECE
1	KANEPE	1
2		
3		
4		
5		
6		
7		
8		
9		
10		
11		
12		
13		
14		
15		
16		
17		
18		
19		
20		
21		
22		
23		
24		
25		
26		
27 A		
27 B		
27 C		
27 D		
28		
29		
30		
31		
32		
33		
34		
35		
36		

MATERIAL PICTURES					
 E3 ALPHE OZGUVANCI SOMUNU 8	 AYK 1 MEGDEL PUSUK 2	 BG MEGDEL PUSUK 2	 CC MEGDEL PUSUK 4	 KS MEGDEL PUSUK 4	 E8 F20 OZGUVANCI SOMUNU 8

In case you need a sparepart, please indicate "Model Code" and "Accessory Code" shown in the assembly instructions.
LET'S PAY ATTENTION TO THE CODE AND LOCATION OF THE MATERIALS WHEN POSITIONING

